

Rhodes[®]

MK8 USER MANUAL

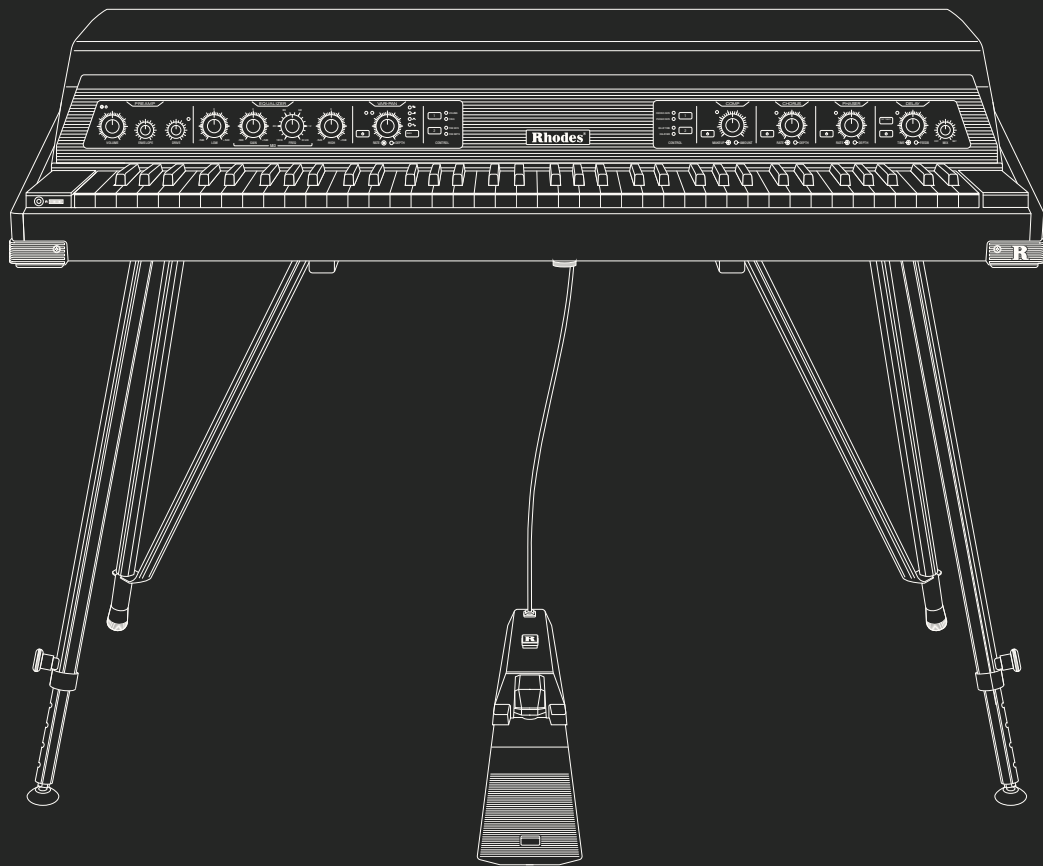

- CN** ⚠️ **警告** 请勿拆卸或改装。为了降低火灾或触电风险，请勿将本设备暴露在雨中或受潮。如果您的手是湿的，请勿处理、连接或断开电源线。如果有雷击可能性，请从交流电源插座上拔下电源线。请勿让易燃或导电材料等异物进入钢琴。不允许任何形式的液体进入。不要在钢琴上存放盛有液体的容器。请勿将钢琴安装在热源附近。⚠️ **警告** 移动钢琴时，请确保按下所有线缆（电源线、延音踏板、耳机、USB、音频线）。⚠️ **一般安全** 确保在移动钢琴之前卸下踏板。请勿在没有监督的情况下让儿童使用。不要堆叠钢琴（可能会掉落）。请确保钢琴至少由两个人搬运。⚠️ **注意** 如需维修服务，请咨询合格的 Rhodes 服务中心或技术人员。详情请访问 www.rhodesmusic.com。联系方式 英国制造。
- CZ** ⚠️ **VAROVÁNÍ** Nerozebírejte ani neupravujte. / Abyste snížili riziko požáru nebo úrazu elektrickým proudem, nevystavujte tento přístroj dešti ani vlhkosti. / Pokud máte mokré ruce, nemanipulujte s napájecím kabelem, nezapojujte jej ani jej neodpojíte. / Pokud existuje možnost úderu blesku, odpojte napájecí kabel ze síťové zásuvky. / Nedovolte, aby se do klavíru dostaly cizí předměty, jako jsou hořlavé nebo vodivé materiály. / Zabraňte vniknutí kapaliny jakéhokoli druhu. / Na klavír neskladujte nádoby s tekutinami. / Neinstalujte klavír do blízkosti zdrojů tepla. ⚠️ **UPOZORNĚNÍ** Při přemísťování klavíru se ujistěte, že jsou odstraněny všechny kabely (napájení, sustain pedál, sluchátka, USB, audio kabely). ⚠️ **VŠEOBECNÉ BEZPEČNOSTNÍ POKYNY** Před přemísťováním klavíru se ujistěte, že je pedál odstraněn. / Nedovolte dětem používat bez dozoru. / Nestavte klavír na sebe (nebezpečí pádu). / Zajistěte, aby klavír přenášely minimálně dvě osoby. ⚠️ **UPOZORNĚNÍ** Opravy nebo servis vám poskytne kvalifikované servisní středisko Rhodes nebo technik. Podrobnosti najdete na www.rhodesmusic.com. KONTAKT support@rhodesmusic.com +44 (0) 113 824 6073 2b Meanwood Close, Leeds, LS7 2JL. Vyrobeno ve Velké Británii
- DK** ⚠️ **ADVARSEL** Må ikke skilles ad eller ændres. / For at reducere risikoen for brand eller elektrisk stød må dette apparat ikke udsættes for regn eller fugt. / Hvis du har våde hænder, må du ikke håndtere, tilslutte eller tage netledningen ud. / Tag netledningen ud af stikkontakten, hvis der er mulighed for lynnedslag. / Lad ikke fremmedlegemer, såsom brændbare eller ledende materialer, trænge ind i klaveret. / Tillad ikke væskeindtrængning af nogen art. / Opbevar ikke beholdere med væske på klaveret. / Installer ikke klaveret i nærheden af varmekilder. ⚠️ **FORSIGTIG** Når du flytter klaveret, skal du sørge for, at alle kabler er fjernet (strøm, sustain-pedal, hovedtelefoner, USB, lyd kabler). ⚠️ **GENEREL SIKKERHED** Sørg for, at pedalen er fjernet, før du flytter klaveret. / Lad ikke børn bruge klaveret uden opsyn. / Stab ikke klaveret (der er risiko for, at det falder ned). / Sørg for, at klaveret bæres af minimum to personer. ⚠️ **BEMÆRK** For reparationer eller service henvises til et kvalificeret Rhodes-servicecenter eller en tekniker. Besøg www.rhodesmusic.com for detaljer. KONTAKT support@rhodesmusic.com +44 (0) 113 824 6073 2b Meanwood Close, Leeds, LS7 2JL. Fremstillet i Storbritannien.
- DE** ⚠️ **WARNHINWEIS** Nicht zerlegen oder verändern. / Um das Risiko eines Brandes oder elektrischen Schlages zu reduzieren, darf dieses Gerät nicht Regen oder Feuchtigkeit ausgesetzt werden. / Wenn Sie nasse Hände haben, dürfen Sie nicht das Netzkabel anfassen, anschließen oder abziehen. / Ziehen Sie das Netzkabel aus der Steckdose, wenn die Gefahr eines Blitzeinschlags besteht. / Fremdkörper, wie etwa entflammbar oder leitende Materialien, dürfen nicht in das Klavier eindringen. / Vermeiden Sie das Eindringen von Flüssigkeiten jeder Art. / Stellen Sie keine Flüssigkeitsbehälter auf dem Klavier ab. / Stellen Sie das Klavier nicht in der Nähe von Wärmequellen auf. ⚠️ **VORSICHT!** Achten Sie beim Verstellen des Klaviers darauf, dass alle Kabel (Netz, Haltpedal, Kopfhörer, USB, Audiokabel) entfernt sind. ⚠️ **ALLGEMEINE SICHERHEIT** Achten Sie darauf, das Pedal zu entfernen, bevor das Klavier verstellt wird. / Lassen Sie Kinder nicht unbeaufsichtigt spielen. / Stapeln Sie das Klavier nicht (Sturzgefahr). / Bitte achten Sie darauf, dass das Klavier von mindestens zwei Personen getragen wird. ⚠️ **ACHTUNG** Wenden Sie sich für Reparaturen oder Service bitte an ein qualifiziertes Rhodes Service-Zentrum oder an einen qualifizierten Rhodes Service-Techniker. Nähere Einzelheiten finden Sie auf www.rhodesmusic.com. KONTAKT support@rhodesmusic.com +44 (0) 113 824 6073 2b Meanwood Close, Leeds, LS7 2JL. Hergestellt im Vereinigten Königreich.
- EN** ⚠️ **WARNING** Do not disassemble or modify. / To reduce the risk of fire or electric shock do not expose this apparatus to rain or moisture. / If you have wet hands, do not handle, connect, or disconnect the power cord. / Remove the power cord from the AC outlet if there is a possibility of a lightning strike. / Do not let foreign objects, such as flammable or conductive materials enter the piano. / Do not allow liquid ingress of any kind. / Do not store containers of liquid on the piano. / Do not install the piano near heat sources. ⚠️ **CAUTION** When moving the piano, ensure all cables are removed (power, sustain pedal, headphones, USB, audio cables). ⚠️ **GENERAL SAFETY** Ensure the pedal is removed before moving the piano. / Do not allow children to use without supervision. / Do not stack the piano (possible chance of falling). / Please ensure that the piano is carried by a minimum of two people. ⚠️ **ATTENTION** For repairs or service please refer to a qualified Rhodes Service Centre or Technician. Please visit www.rhodesmusic.com for details. CONTACT support@rhodesmusic.com +44 (0) 113 824 6073 2b Meanwood Close, Leeds, LS7 2JL. Made in the UK.
- ES** ⚠️ **ADVERTENCIA** No desmontar ni modificar. / Para reducir el riesgo de descarga eléctrica, no exponer este aparato a la lluvia o la humedad. / Si tiene las manos húmedas no manipule, conecte o desconecte el cable de alimentación. / Desenchufe el cable de alimentación de la toma de CA si existe la posibilidad de que caiga un rayo. / No permita que objetos extraños, como materiales inflamables o conductores se introduzcan en el piano. / No permita la entrada de líquidos de ningún tipo. / No almacene recipientes con líquido en el piano. / No instale el piano cerca de fuentes de calor. ⚠️ **PRECAUCIÓN** Al mover el piano, asegúrese de retirar todos los cables (alimentación, pedal, auriculares, USB, cables de audio). ⚠️ **SEGURIDAD GENERAL** Asegúrese de retirar el pedal antes de mover el piano. / No permita que los niños lo usen sin supervisión. / No apile el piano (existe la posibilidad de que caiga). / Asegúrese de que el piano lo trasladen un mínimo de dos personas. ⚠️ **ATENCIÓN** Para tareas de reparación o mantenimiento, consulte a un Centro de Asistencia o un Técnico cualificado de Rhodes. Visite www.rhodesmusic.com para conocer más detalles. CONTACTO support@rhodesmusic.com +44 (0) 113 824 6073 2b Meanwood Close, Leeds, LS7 2JL. Fabricado en el Reino Unido.
- FI** ⚠️ **VAROITUS** Älä pura tai muokkaa. / Tulipalon tai sähköiskun vaaran vähentämiseksi älä altista laitetta sateelle tai kosteudelle. / Jos kätesi ovat märät, älä käsittele, liitä tai irrota virtajohtoa. / Irrota virtajohto pistorasiasta, jos on olemassa salamiskin mahdollisuus. / Älä päästä vieraita esineitä, kuten syttyviä tai johtavia materiaaleja, pianon sisään. / Älä päästä minkäänlaista nestettä sisään. / Älä säilytä nestettä sisältäviä astioita pianon päällä. / Älä asenna pianoa lämmönlähteiden lähelle. ⚠️ **VAARA** Kun siirrät pianoa, varmista, että kaikki kaapelit on irrotettu (virtajohto, sustain-pedaali, kuulokkeet, USB, äänikaapelit). ⚠️ **YLEINEN TURVALLISUUS** Varmista, että pedaali on irrotettu, ennen kuin siirrät pianoa. / Älä anna lasten käyttää ilman valvontaa. / Älä pinota pianoa (mahdollinen putoaminen). / Varmista, että pianoa kuljettaa vähintään kaksi henkilöä. ⚠️ **HUOMIO** Käännä pätevän Rhodes-huoltokeskuksen tai teknikon puoleen korjauksia tai huoltoa varten. Katso lisätietoja osoitteesta www.rhodesmusic.com. YHTEYSTIEDOT support@rhodesmusic.com +44 (0) 113 824 6073 2b Meanwood Close, Leeds, LS7 2JL. Valmistettu Iso-Britanniassa.
- FR** ⚠️ **MISE EN GARDE** Ne démontez pas le piano et n'y apportez aucune modification. / Pour réduire le risque d'incendie ou de choc électrique, n'exposez pas cet appareil à la pluie ou à l'humidité. / Si vous avez les mains mouillées, ne manipulez pas, ne branchez pas et ne débranchez pas le cordon d'alimentation. / Retirez le cordon d'alimentation de la prise secteur s'il y a un risque que la foudre s'abatte. / Ne laissez pas d'objets étrangers, tels que des matériaux inflammables ou conducteurs, pénétrer dans le piano. / Ne laissez pas de liquide pénétrer dans l'instrument, quel qu'il soit. / Ne stockez pas de récipients contenant des liquides sur le piano. / N'installez pas le piano à proximité de sources de chaleur. ⚠️ **ATTENTION** Lorsque vous déplacez le piano, assurez-vous que tous les câbles sont retirés (alimentation, pédale de sustain, casque, USB, câbles audio). ⚠️ **SÉCURITÉ GÉNÉRALE** Assurez-vous que la pédale est retirée avant de déplacer le piano. / Ne laissez pas les enfants l'utiliser sans surveillance. / N'empilez pas d'objets sur ou sous le piano (risque possible de chute). / Veuillez vous assurer que le piano est porté par un minimum de deux personnes. ⚠️ **AVERTISSEMENT** Pour les réparations ou la maintenance, veuillez vous adresser à un centre de maintenance ou à un technicien Rhodes qualifié. Veuillez consulter le site www.rhodesmusic.com pour obtenir plus de détails. CONTACT support@rhodesmusic.com +44 (0) 113 824 6073 2b Meanwood Close, Leeds, LS7 2JL. Fabriqué au Royaume-Uni.
- HR** ⚠️ **UPOZORENJE** Nemojte rastavljati ili vršiti izmjene. / Kako biste smanjili rizik od požara ili strujnog udara, nemojte izlagati ovaj uređaj kiši ili vlazi. / Imate li mokre ruke, nemojte rukovati, spajati ili odspajati kabel napajanja. / Izvadite kabel napajanja iz utičnice za izmjeničnu struju ako postoji mogućnost udara munje. / Ne dopustite da strani predmeti, kao što su zapaljivi ili provodljivi materijali, uđu u klavir. / Nemojte dopustiti prodiranje bilo kakve tekućine. / Ne ostavljajte posude s tekućinom na klaviru. / Nemojte postavljati klavir blizu izvora topline. ⚠️ **OPREZ** Prilikom pomicanja klavira vodite računa o tome da su uklonjeni svi kabeli (napajanje, pedala za sustain, slušalice, USB, audiokabeli). ⚠️ **OPCA SIGURNOST** Vodite računa o tome da pedala bude uklonjena prije pomicanja klavira. / Ne dopustite djeci uporabu bez nadzora. / Ne postavljajte klavir na druge predmete (moguć je pad). / Vodite računa o tome da klavir nose najmanje dvije osobe. ⚠️ **POZORNOST** Radi popravka ili servisa obratite se kvalificiranom servisnom centru ili tehničaru tvrtke Rhodes. Pojednostosti potražite na www.rhodesmusic.com. KONTAKT support@rhodesmusic.com +44 (0) 113 824 6073 2b Meanwood Close, Leeds, LS7 2JL. Proizvedeno u UK.
- ID** ⚠️ **PERINGATAN** Jangan membongkar atau memodifikasinya. / Untuk mengurangi risiko kebakaran atau sengatan listrik, jangan biarkan instrumen ini terkena hujan atau lembab. / Jika tangan Anda basah, jangan memegang, memasang, atau melepaskan kabel daya. / Cabut kabel daya dari stopkontak jika ada kemungkinan tersambar petir. / Jangan biarkan benda-benda asing, seperti bahan yang mudah terbakar atau bahan konduktif masuk ke dalam piano. / Jangan biarkan masuknya cairan dalam bentuk apapun. / Jangan menyimpan wadah yang berisi cairan di atas piano. / Jangan menyimpan piano di dekat sumber panas. ⚠️ **PERHATIAN** Jika Anda memindahkan piano, pastikan semua kabel telah dilepaskan (kabel daya, pedal penopang, headphone, USB, dan kabel audio). ⚠️ **KEAMANAN UMUM** Pastikan pedalnya dilepaskan sebelum memindahkan piano. / Jangan biarkan anak-anak menggunakan tanpa pengawasan. / Jangan menumpuk piano (karena berpotensi jatuh). / Pastikan bahwa piano diangkat oleh minimal dua orang. ⚠️ **PERHATIAN** Untuk melakukan perbaikan atau servis, silakan hubungi Service Center atau Teknis Rhodes yang terlatih. Kunjungi www.rhodesmusic.com untuk detail selengkapnya. KONTAKT support@rhodesmusic.com +44 (0) 113 824 6073 2b Meanwood Close, Leeds, LS7 2JL. Dibuat di Inggris.
- IT** ⚠️ **FARE ATTENZIONE** Non disassemblare o modificare. / Per ridurre il rischio di incendi o scosse elettriche, non esporre l'apparecchio alla pioggia o all'umidità. / Non maneggiare, collegare o scollegare il cavo di alimentazione con le mani bagnate. / In caso vi sia il rischio di fulmini, scollegare il cavo di alimentazione dalla presa CA. / Non permettere che nel piano entrino oggetti estranei, ad esempio materiali infiammabili o conduttivi. / Non permettere che vengano inseriti in alcun modo liquidi. / Non conservare contenitori di liquidi sul piano. / Non posizionare il piano vicino a fonti di calore. ⚠️ **PRECAUZIONI** Quando si sposta il piano, assicurarsi che tutti i cavi siano scollegati (cavo di alimentazione, del pedale del sustain, delle cuffie, USB, audio). ⚠️ **SICUREZZA GENERALE** Assicurarsi che il pedale sia stato rimosso prima di spostare il piano. / Non permettere ai bambini di utilizzarlo senza supervisione. / Non impilare il piano (vi è la possibilità di caduta). / Assicurarsi che il trasporto del piano sia effettuato da almeno due persone. ⚠️ **ATTENZIONE** Qualora fossero necessarie riparazioni o manutenzione, rivolgersi a un centro di assistenza o tecnico Rhodes qualificati. Visitate il sito www.rhodesmusic.com per ulteriori informazioni. RECAPITO support@rhodesmusic.com +44 (0) 113 824 6073. 2b Meanwood Close, Leeds, LS7 2JL. Prodotto nel Regno Unito.

Foreword

Thank you for purchasing the Rhodes MK8, the latest and (we believe the greatest) tine piano ever created.

When I was first approached by Rhodes CEO Matt Pelling in early 2019, I thought that Matt was calling me to repair his own Rhodes piano, but unbeknownst to me, he was approaching me to become CPO at the newly formed Rhodes Music Group and to head up a new UK-based team tasked with designing from the ground up, a brand-new electro-mechanical Rhodes piano.

Fast forward to the present time and now you have your very own MK8 in front of you. This is a Rhodes in the truest sense of the word, a piano we truly hope Harold Rhodes would be proud of.

The MK8 is the latest iteration of previous classic Rhodes pianos and once again you'll find our famous tines (though this time black), dampers, pickups- in fact, all the classic (and much improved) ingredients that we all love about Rhodes pianos. However, this time, it's a precision-built instrument and the utmost care has been put into every part of the piano to

ensure that it maintains the highest production standards throughout. We have also included ground-breaking features/electronics and a unique to Rhodes Kluge (Steinway Group) keyboard, whilst also shaving off considerable weight and retaining the unmistakable Rhodes silhouette, this time with the help of legendary industrial designer Axel Hartmann.

It's truly an honour and a pleasure to be part of this unique and loyal community and now through your ownership of the MK8 you have also directly become part of the unique Rhodes story.

Myself and the entire Rhodes team wish you a lifetime of enjoyment and boundless creativity with your MK8 and hope that it is everything you dreamed of and more.

Dan Goldman
CPO, Rhodes Music Group



Contents

FUNCTION OVERVIEW DIAGRAM	1
CONNECTION OVERVIEW	3
SETTING UP YOUR MK8	4

CHAPTER 1

USING THE ONBOARD PREAMP

Preamp Section	5
EQ Section	6
Vari-Pan Section	8

CHAPTER 2

USING THE ONBOARD ANALOG FX

Compressor	10
Stereo Analog Chorus	12
Stereo Analog Phaser	13
Stereo Analog Delay	14

CHAPTER 3

ALTERNATIVE MODE (PREAMP AND FX MODELS)

An Intro To Alternative Mode	16
Navigating And Entering Alternative Mode	16
Adjusting Parameters While In Alternative Mode	16
Leaving Alternative Mode	16
Restoring Default Settings	16
Preamp and FX Section Alternative	
Mode Quick Overview	17
Alternative Mode Front Panel Control Map	18

CHAPTER 4

CONTROL INPUTS 1 & 2 / USING EXPRESSION PEDALS

Connecting And Assigning	19
Control Input 1	20
Control Input 2	21
Connecting And Assigning (FX Model)	22
Hidden Slow Phaser Effect	23
Calibrating Your Expression / Control Inputs	23

CHAPTER 5

TUNING, VOICING AND MAINTENANCE

Tuning	24
Voicing	24
Ideal Time To Pickup Settings	24
Cleaning Your MK8	24

CHAPTER 6

Troubleshooting	25
Sound Setting Examples	26
Credits	28
Warranty	28
Technical Specifications	29

Feature Overview

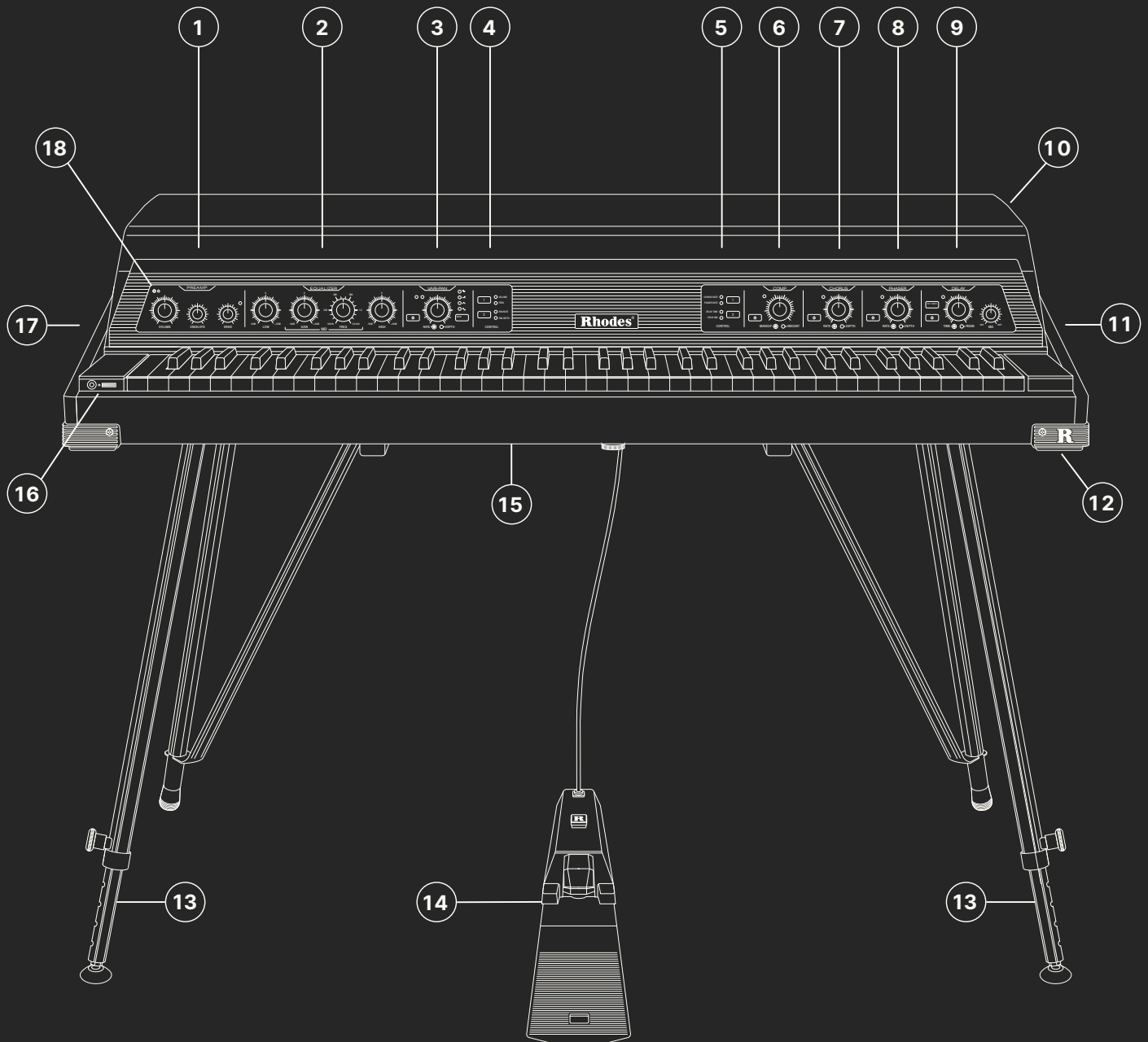

- | | | | |
|--------------------------------|----------------------------|------------------------|-----------------------------------|
| 1. PREAMP | 6. COMPRESSOR | 12. PROTECTIVE CORNERS | 16. HEADPHONES + HEADPHONE VOLUME |
| 2. EQUALIZER | 7. CHORUS | 13. ADJUSTABLE STAND | 17. LEFT CONNECTION PANEL |
| 3. VARI-PAN | 8. PHASER | 14. PEDAL | 18. POWER LED |
| 4. EXPRESSION CONTROL (PREAMP) | 9. DELAY | 15. WOODEN SHELL | |
| 5. EXPRESSION CONTROL (FX) | 10. FLAT TOP HOOD | | |
| | 11. RIGHT CONNECTION PANEL | | |

⚠ Ear Health Warning: When using headphones, high levels of volume can occur at certain settings, resulting in potential hearing damage. Please take care to keep your headphone volume level as low as possible at all times and try to not to use headphones at high monitoring levels for extended periods of time.

Feature Overview Continued...

1. REMOVABLE BADGE

For sustain mechanism access
(Please contact Rhodes support before adjusting).

2. BUMPERS

For standing the piano on its back.

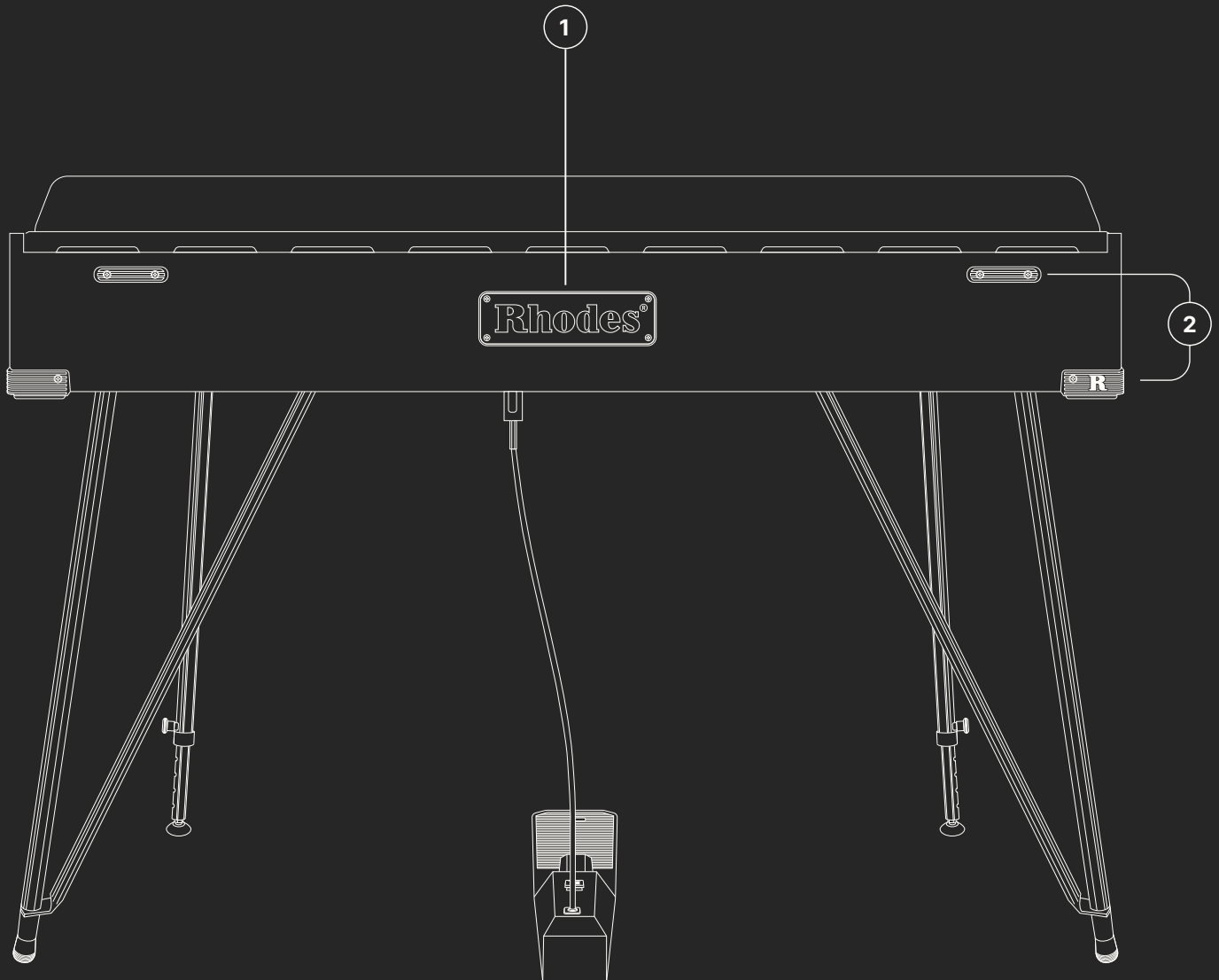

Connection Overview

LEFT SIDE CONNECTION PANEL

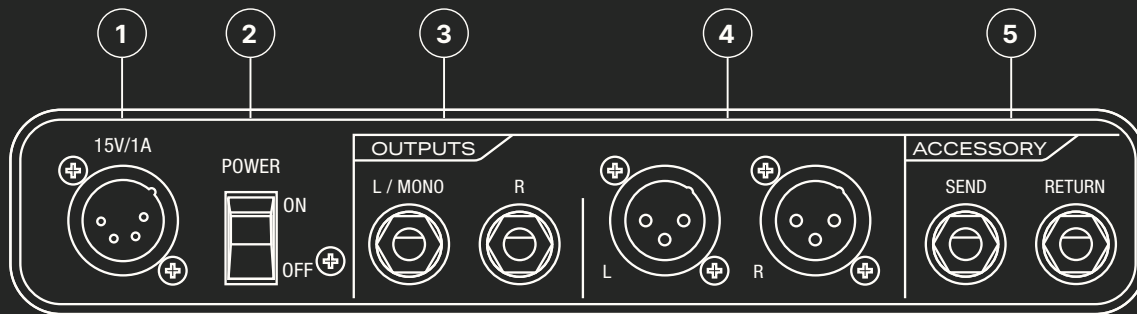

1. POWER INPUT

Connect the included external power supply here.

2. POWER SWITCH

Flick this switch to power on your MK8.

3. 1/4 INCH JACK OUTPUTS

(UNBALANCED)

Connect the left jack only for mono or both the left and right jacks for stereo output.

⚠ Please Note: Ensure you pan the inputs on your mixer or soundcard hard left and hard right for full stereo.

4. XLR OUTPUTS (BALANCED)

Plug these into any MIC level inputs (Mixer, Mic Pre etc).

⚠ Please Note: All outputs (jacks, XLR's & Send) can be used simultaneously.

5. ACCESSORY JACKS (SEND AND RETURN 1/4 INCH JACKS)

Use these jacks as an FX loop to patch in your favourite FX pedals

⚠ To run external audio through the Preamp and/or FX, plug straight into the RETURN jack and adjust the incoming level using

or processors. Alternatively, plug in any external audio equipment (such as drum machines and synths) for processing through the MK8's Preamp and FX sections.

the output/volume level on your external audio source.

⚠ For inserting pedals into the FX loop: Plug a cable from the Send jack into your pedal's input and take a cable from your pedal's output into the Return socket. For external audio, plug into the Return socket only.

⚠ Plug in a cable from the SEND jack for a direct from pickup signal, whilst simultaneously using the jack and/or XLR outs in stereo.

RIGHT SIDE CONNECTION PANEL

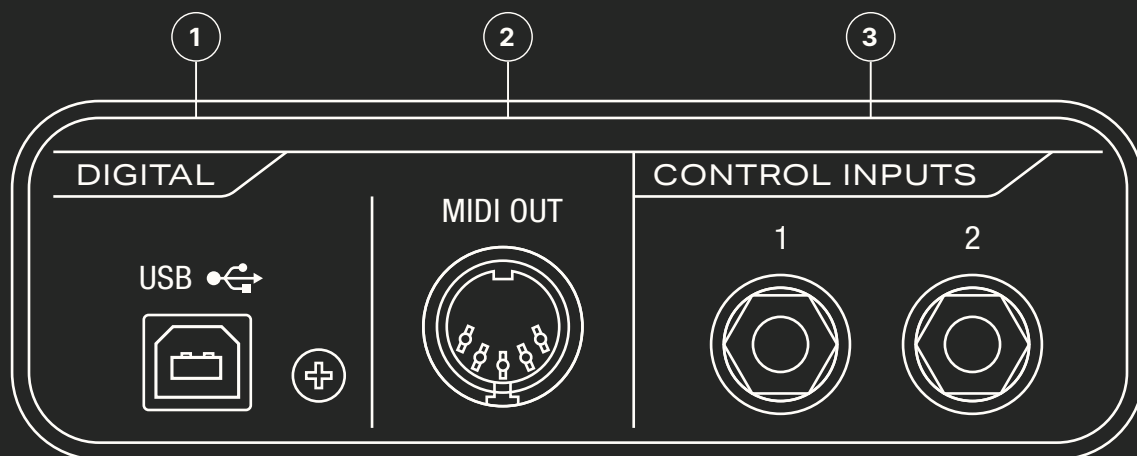

1. USB

(TYPE B CONNECTOR)

For updating firmware and future MIDI feature upgrades.

2. MIDI OUT

Reserved for future MIDI feature upgrades.

3. CONTROL INPUTS

(1/4 INCH JACKS)

1 & 2 For connecting expression pedals.

⚠ These control inputs accept CV from modular synths and clocks (0-5 volts input).

Setting Up Your MK8

Please refer to the QUICKSTART GUIDE for quick setup instructions, along with the included safety guide.

⚠ Please Note: The Quickstart Guide and Safety Guide can both be found in the MK8 shipping box or online in the Rhodes Members Club area of the Rhodesmusic.com website.



Members Club

Your Rhodes Members Club card grants you exclusive access to the Rhodes Members Club area where you will find MK8-specific documents and videos. Scan the QR code on your Members Club Card for instant access, or simply follow this URL: <https://rhodesmusic.com/membersclub> to register and login.

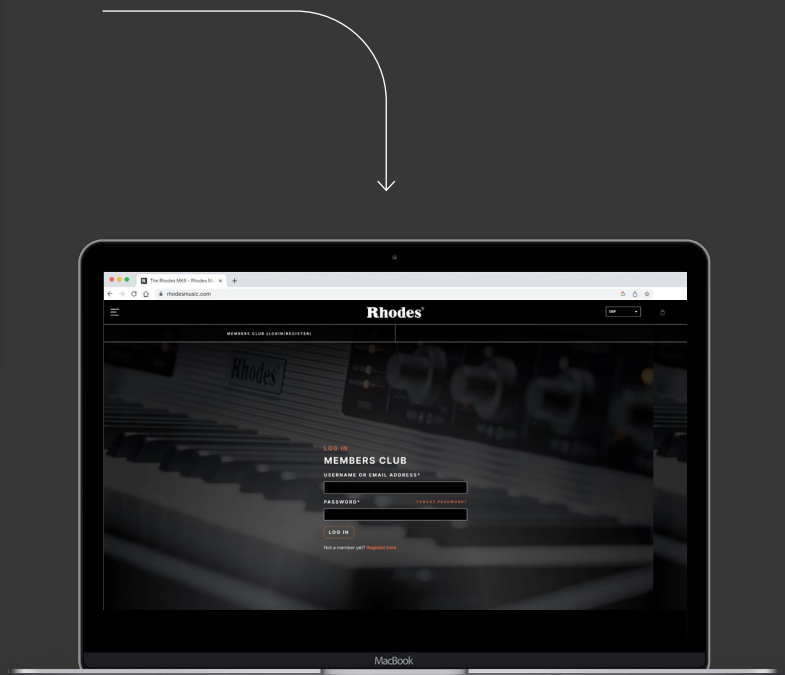
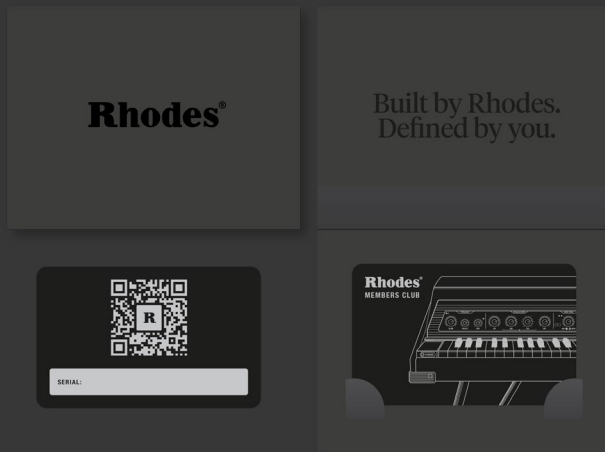

Chapter 1

USING THE ONBOARD PREAMP

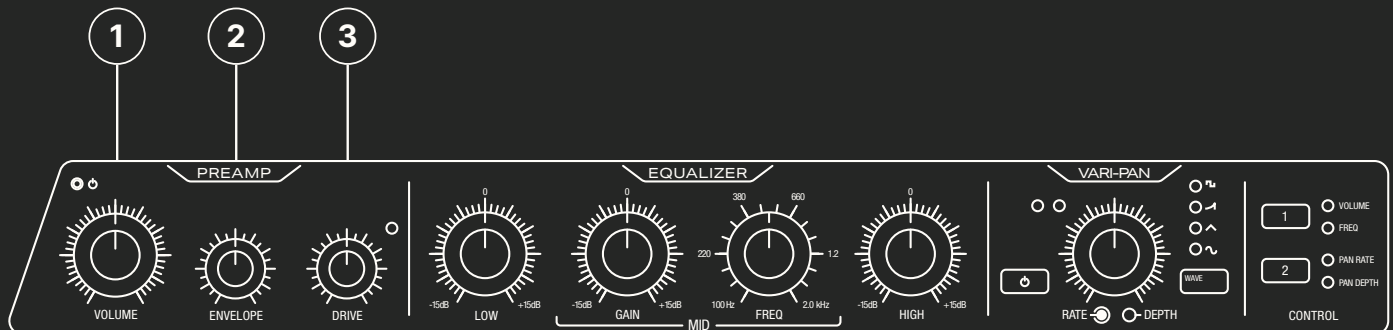

PREAMP SECTION

The Rhodes MK8 includes the most advanced analog preamp ever found in a Rhodes piano. Here's a rundown of each control:

1. **VOLUME** Turn this up or down to vary the main output level coming from the jack and XLR outputs.

⚠ **Please Note: Volume can be assigned to an expression pedal, see chapter 'Control Inputs 1 & 2 / Using Expression Pedals' on Page 19 for details.**

⚠ **Although volume is first in line, this control is positioned at the end of the MK8's signal path.**

2. **ENVELOPE** This control works in conjunction with the resonant voltage-controlled mid range filter and can be thought of much like an 'amount to filter' control as found on most analog subtractive synthesizers. It allows the keyboard level to control the input to the filter for classic auto-wah/touch-wah effects.
3. **DRIVE** This is a diode-based analogue drive that responds to velocity and can produce a wide range of driven sonics, from subtle breakup to unhinged all-out saturation.

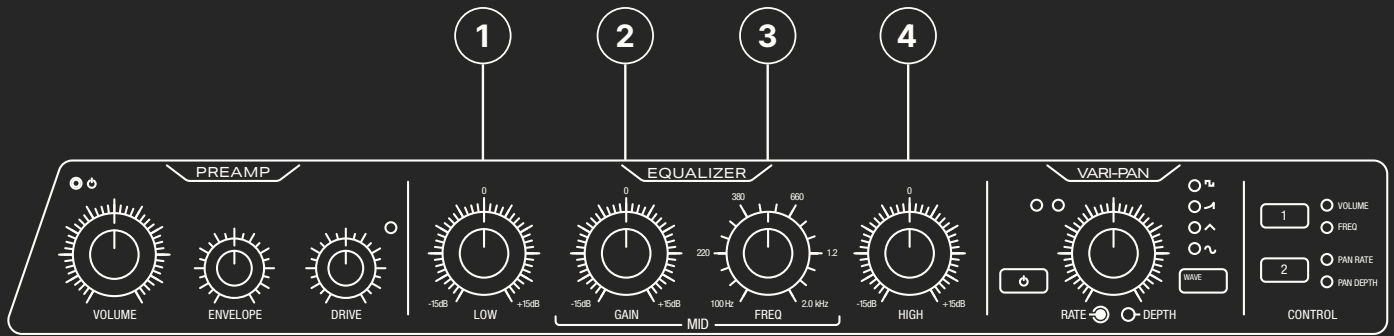

EQ SECTION

- 1. LOW** This control offers +/- 15 dB of gain control centred around 75Hz. For more bass turn the control clockwise- for less bass turn the dial anti-clockwise.
- 2. MID GAIN** This control cuts or boosts the mid frequency by +/- 15db. The frequency of the boost is dependent on the setting of the mid frequency control.
- 3. MID FREQUENCY** (100hz to 2.0kHz). This control has two functions. Firstly (in combination with the MID GAIN control) you can boost or remove peak frequencies by 15db to taste.



Secondly, it is used in conjunction with the Envelope dial in the preamp section to select the starting frequency of the auto-wah. For example, for more effect on the lower frequencies, turn the dial anti-clockwise, for more effect on the higher frequencies turn the dial clockwise.

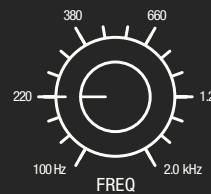

Thirdly, turn both MID GAIN and FREQ fully counter-clockwise, assign to an expression pedal (see Chapter 4 'CONTROL INPUTS 1 & 2 / USING EXPRESSION PEDALS' on Page 19) and the unique 'slow phase' function can be accessed.

- 4. HIGH** this is a parametric-type eq centred around 3KHz for boosting or cutting the high end of the piano by +/- 15db. Turn clockwise to boost the highs and anti-clockwise to remove highs for a more mellow sound.



EQ SECTION

Sound setting Examples:



HIGH BOOST



LOW BOOST



MID BOOST



MID SCOOP



BELLS

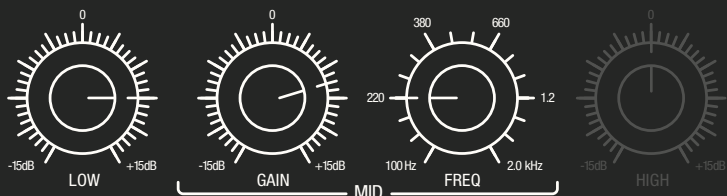

FAT



THIN

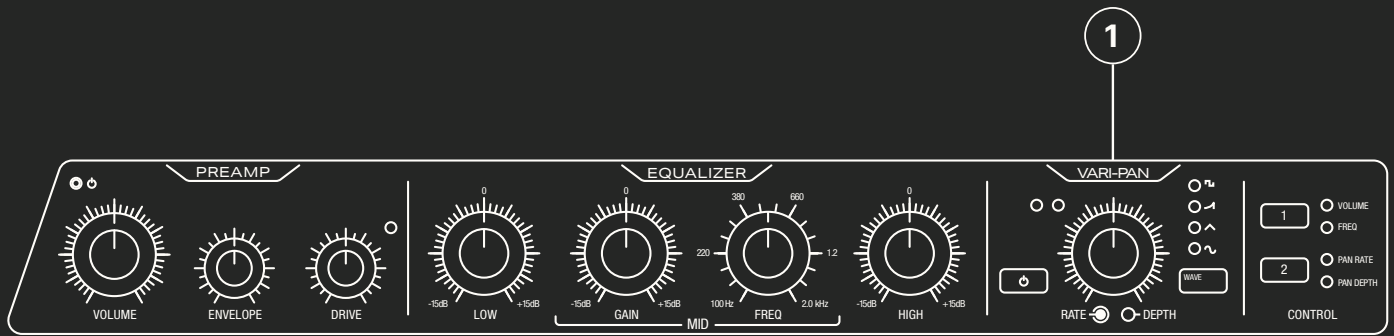

VARI-PAN SECTION

The Vari-Pan feature **(1)** is unique to the MK8. It takes the classic Rhodes vibrato/panning and pushes it forward into altogether new sonic territories.

The 2 LED's in the Vari-Pan section show the left **(2)** and right **(3)** audio channels. These LED's are always on by default and switch in and out according to the rate and depth settings.

The wide frequency range available via the Rate control allows both classic Rhodes panning and unique audio-modulated effects. Ring modulation, transistor organ tones and synth-esque textures are all just a dial turn away.

⚠ Used in conjunction with the envelope control and mid filter, modulated filter effects can also be easily achieved.

- 4. ON/OFF** This switches the Vari-Pan circuit on/off.
- 5. RATE** Controls the rate of the LFO and hence the panning speed from 0.1Hz to 3KHz.
- 6. DEPTH** Controls the stereo image of the effect in stereo or depth of the mono pulse when only one output is connected to a mono amplifier.
- 7. WAVE** This button selects from one of the 4 waveshapes (square, upwards ramp, triangle and sine). Each has it's own unique texture.

⚠ Please Note: Vari-Pan Rate and Depth can be assigned to an expression pedal, see Chapter 4 'Control Inputs 1 & 2 / Using Expression Pedals' on Page 19 for details.

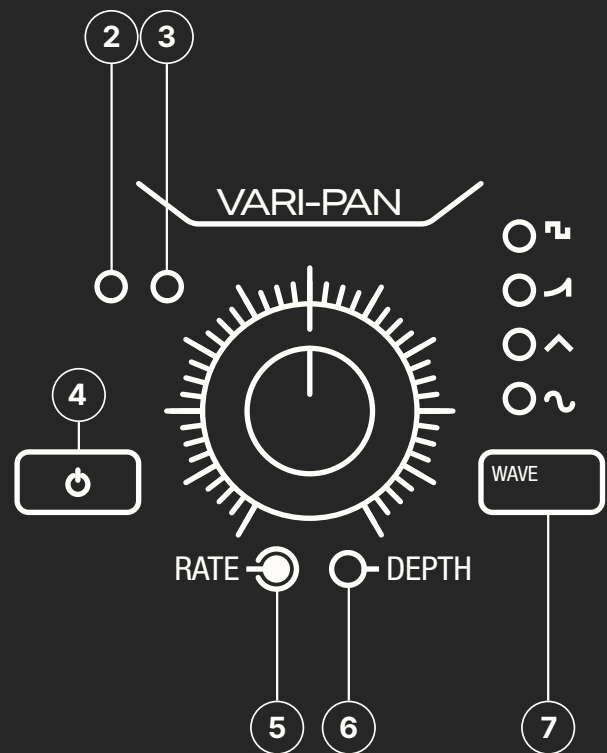

VARI-PAN

Sound Setting Examples:

CLASSIC SQUARE PAN



SLOW PAN



RING-MOD ESQUE



SUPER-WIDE

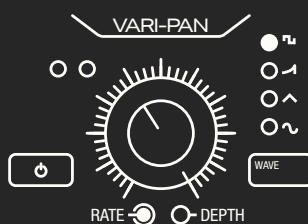

RAMP PAN



FAST-PANNER



TRIANGLE PAN



RHODES/AUDIOMOD MIX

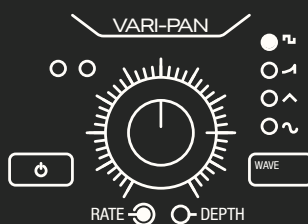

TRANSISTOR ORGAN-ISH



SINE PAN



Chapter 2

USING THE ONBOARD ANALOG FX

The MK8 FX version contains all the most user-requested classic analog effects including a VCA-based compressor, mono in/stereo out phaser, plus stereo BBD chorus and delay. These effects have been designed and tuned specifically for the MK8.

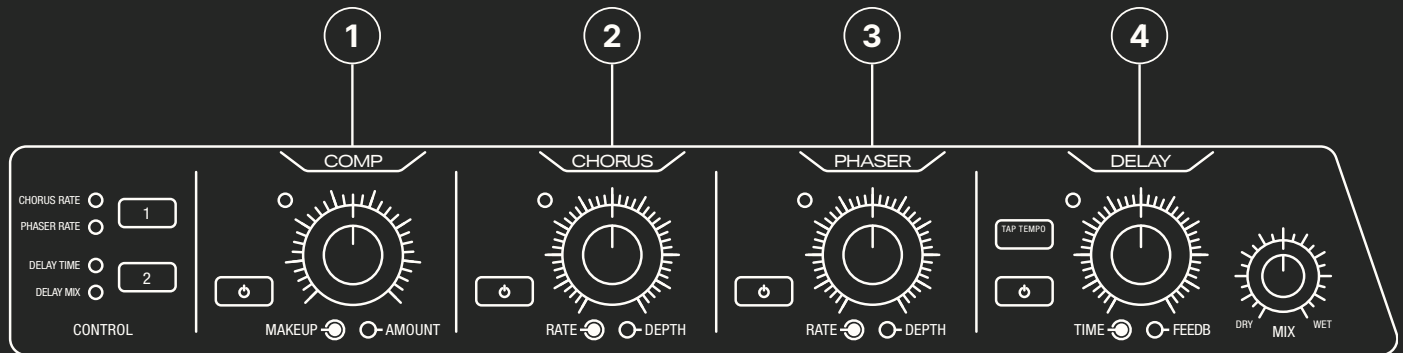

1

COMPRESSOR

The compressor can be used subtly to tame and flatten peaks in the sound, to enhance the attack, or to really squash the sound for a more exaggerated, ducking/pumping effect.

ON/OFF

Powers on or off the compressor circuit.

COMPRESSOR LED

Shows the amount of compression taking place; the brighter the LED the more compression that is taking place.

AMOUNT

Use the Amount control to control the amount of compression effect heard.

MAKEUP

To compensate for volume loss when compressing the signal, turn up Makeup to taste.



COMPRESSOR EXAMPLE SETTINGS

GAIN BOOST



SOFT COMPRESSION



MEDIUM COMPRESSION



HARD COMPRESSION



⚠ Please note: Use the GAIN control to compensate for any volume loss as the compression Amount is increased.

⚠ Ear Health Warning! Please note that when using the compressor gain dial at high levels (along with the envelope control and mid filter gain control), because the compressor comes before the mid filter in the signal chain, the compressor can drive the filter into very high levels of filter resonance and thus, potential hearing damage can occur. Please use this function with caution!

2

STEREO ANALOG CHORUS

The chorus effect is a classic 'bucket-brigade' effect used for thickening /doubling and adding subtle or more aggressive pitch modulation.

The analog chorus on the MK8 is a true stereo chorus with individual chorus circuits for each channel allowing for a much richer, deeper stereo chorus effect.

ON/OFF

Switches the chorus effect on or off.

CHORUS LED

This shows the chorus rate and depth (as governed by the Chorus RATE and DEPTH controls).

RATE

Controls the rate of modulation.

DEPTH

Controls the depth of modulation.

! *Please Note: Chorus Rate and Depth can be assigned to an expression pedal, see Chapter 4 'Control Inputs 1 & 2 / Using Expression Pedals' on Page 19 for details.*

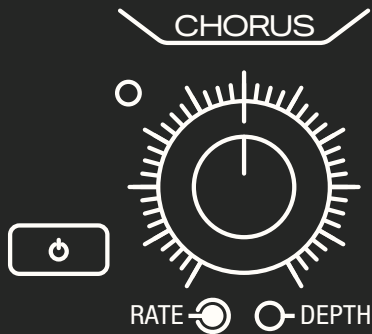

CHORUS EXAMPLE SETTINGS

STEREO-WIDENING

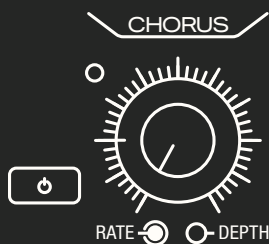

CLASSIC CHORUS

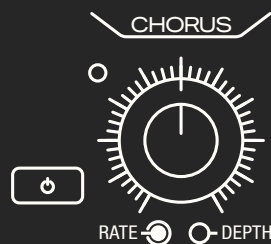

CHORUS-VIBRATO

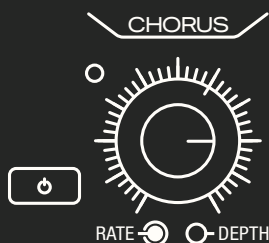

DEEP CHORUS

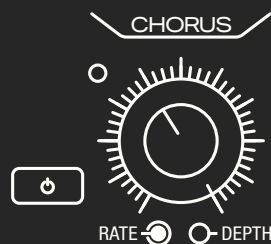

3

STEREO ANALOG 4-STAGE PHASER

The MK8 phaser allows subtle phasing and more extreme phase-modulated effects.

ON/OFF

Use this to power the phaser on or off.

PHASER LED

This shows the phaser rate and depth (as governed by the Phaser RATE and DEPTH controls).

RATE

Use this dial to set the desired phaser speed.

DEPTH

Use this dial to govern the amount of effect applied.

! *Please Note: Phaser Rate and Depth can be assigned to an expression pedal, see Chapter 4 'Control Inputs 1 & 2 /Using Expression Pedals' on Page 19 for details.*

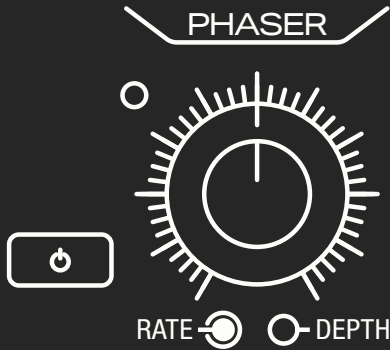

PHASER EXAMPLE SETTINGS

SLOW PHASING

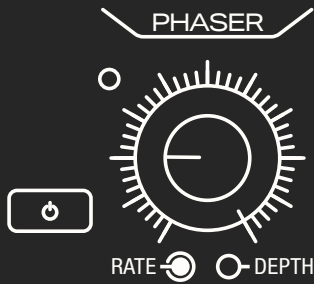

70'S PHASER

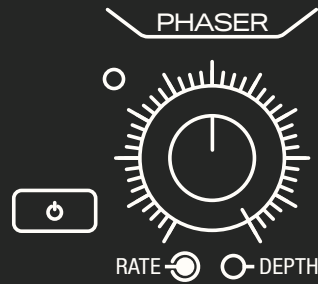

PHASE - WAH

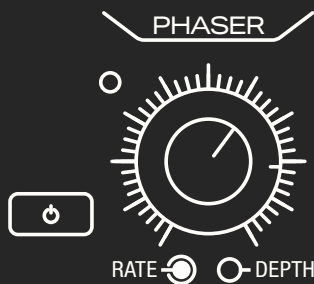

CLASSIC PHASER

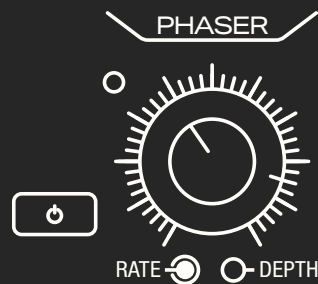



STEREO ANALOG DELAY

This bucket brigade delay circuit can be used for ambience, creating atmosphere, pitch shift effects, swell effects, reverb like effects, adding sustain and much more. It has a 60msec shortest time and a 0.8sec longest time.

The analog delay circuit on the MK8 is a true stereo delay with individual delay circuits for each channel allowing for a richer delay texture whilst also preserving the stereo image of the stereo phaser and chorus circuits.

DELAY LED

This shows the delay rate (as governed by the time dial).

ON/OFF

Switches the delay effect on or off.

⚠ Please Note: Note the delay has a 'spill over' function that allows the delay tails to carry on after the effect has been powered off.

TAP TEMPO

Repeatedly tapping the Tap Tempo button overrides the TIME control and allows manual synchronisation of the delay repeats by tapping the button in time with any audio you are playing along with.

For example, if you are playing live with a band, tap the button in time with your drummer/bassist/guitarist to bring the delay repeats into sync with the beat/tempo of the music being played. The button will light up once tapped to show Tap Tempo mode is active.

⚠ Please Note: Once the TIME dial is turned again, this will override the current Tap Tempo setting, the Tap Tempo light will switch off, and you have exited Tap Tempo Mode.

⚠ The accuracy of the TAP TEMPO is determined by the averaging of the taps. Typically, it requires a minimum of three good taps to lock in accurately, but the more you tap, the more accurate your tempo will be.

TIME

Determines the min or maximum length of the delay effect from 60ms to 0.8secs.

⚠ Please Note: longer times are available when using TAP TEMPO.

FEEDBACK

This control determines how much of the delay's output is fed back into itself for sustained and special FX.

When turned all the way counter-clockwise, there is no feedback applied and so there is only one "echo" produced from the circuit. As feedback is increased, more echos are produced creating the classic tail of analog delays.

As feedback is further increased, a sustained feedback will be produced allowing the instrument to become drone-like. At first, this feedback is still coherent with the harmonics closely resembling the input harmonics. However, as the feedback is turned to fully clockwise, the classic analog distortion of bucket-brigade devices takes over producing drones that go from subtle to gritty and extreme.

5

MIX

This controls the blend of dry unaffected Rhodes signal with the wet effected amount.

⚠ Please Note: Both Time and Mix can be assigned to an expression pedal connected to Control Input 2, See Chapter 4 'Control Inputs 1 & 2 / Using Expression Pedals' on Page 19 for details.



DELAY EXAMPLE SETTINGS

QUICK-VERB



MEDIUM DELAY



SHORT TAILS



SLOW FEEDBACK



Chapter 3

AN INTRO TO ALTERNATIVE MODE

The MK8 contains an extremely advanced analog control system to modify the performance of both the onboard pre-amp and FX and the front panel brings immediate control to the most intuitive and useful playing controls. However, for those that want to explore the sonic depth of the MK8 further, we have included several “alternative functions” that can be controlled when in “alternative mode”.

These “under the hood” features can be adjusted in real-time and saved (values are held even after the instrument is turned off and restored on power-up). Additionally, there is an easy way (explained below) to “restore” the hardware to the factory default for these features.

ENTERING ALTERNATIVE MODE

Press and hold the power on/off button for the parameter section you want to adjust until the button starts blinking at a steady rate of about 1Hz (one time a second). You are now in Alternative Mode for that section.

LEAVING ALTERNATIVE MODE

To leave Alternative Mode, simply press the associated power on/off button again (once) and the button will stop blinking. You are now back in normal mode. Whatever the last knob setting(s) for the alternative mode feature you were changing was at the time of leaving alternative mode, will remain in effect even across power cycles. In effect, you have set a new “user default value” for that feature.



ADJUSTING PARAMETERS WHILE IN ALTERNATIVE MODE

While in Alternative Mode, turning the knob for that parameter will adjust the alternative parameter, not the normal labelled parameter for that knob. For example, if you have enabled alternative mode for the PAN ON/OFF button and it is blinking slowly, adjusting the MID-FREQ knob will now change the RESONANCE-AMOUNT for the MID-FILTER (not the MID-FREQ as per normal operation). The value of the MID-FREQ will remain as previously set until you leave Alternative Mode and move the knob(s) again.

RESTORING DEFAULT SETTINGS

To quickly return any of the Alternative Mode parameters to its factory default, simply enter Alternative Mode (press and hold the power on/off button for that section until it's blinking slowly), then press+hold the On/Off button again for that section for 3 seconds. At this point, the button will blink rapidly for a second, indicating that the factory default value for that feature has been restored and you will be returned to normal mode

 **Please note: for a deeper technical explanation of alt mode parameters, please refer to the alternative mode manual here: <https://rhodesmusic.com/membersclub>**

PREAMP SECTION ALTERNATIVE MODE FEATURES QUICK OVERVIEW:

DRIVE VCA AMOUNT:

This adjusts the AUDIO level coming out of the drive circuit that goes into the EQ section allowing for differing EQ characters.

FX SEND VCA AMOUNT:

This adjusts the AUDIO level coming out of the EQ circuit into the routing section of the FX electronics and allows you to adjust the level of audio going into the FX section.

MID-FREQUENCY RESONANCE AMOUNT:

This control allows you to reduce the resonance amount to “off” so that the filter becomes a broad mid-frequency EQ, all the way to very sharp resonance to get more peaked responses around the frequency setting.

FX SECTION ALTERNATIVE MODE FEATURES QUICK OVERVIEW:

COMPRESSION RATIO:

Use this to change the compressor ratio response for softer or harder compression characters. Also use this if you want to increase the volume into the DRIVE circuit to get even more intensely compressed DRIVE sounds.

CHORUS TIME:

The CHORUS TIME alternative control allows you to “tune” the center time of the Chorus modulation, or rather, where the chorus delay time is when DEPTH is OFF. By moving this around, you are changing the range of frequencies that are acted on by the chorus and hence you are adjusting the color (character) of the chorus.

PHASER FREQUENCY:

Adjusting the PHASER FREQUENCY allows you to select the center frequency of this LFO adjusting the effective frequency range of the phaser. For instance, increasing the phaser center frequency shifts the phaser notches higher in pitch. Likewise, decreasing the phaser center frequency shifts the phaser notches lower in pitch.

DELAY SPREAD AMOUNT:

With just a bit of spread, this yields a subtle stereo imaging. As spread is increased, the stereo imaging effect increases dramatically.

DELAY JITTER AMOUNT:

Delay Jitter emulates random shimmering of delays and tape wobble, all the way to radical sample-hold time modulation effects.

Alternative Mode Continued...

PREAMP ALTERNATIVE MODES MAP

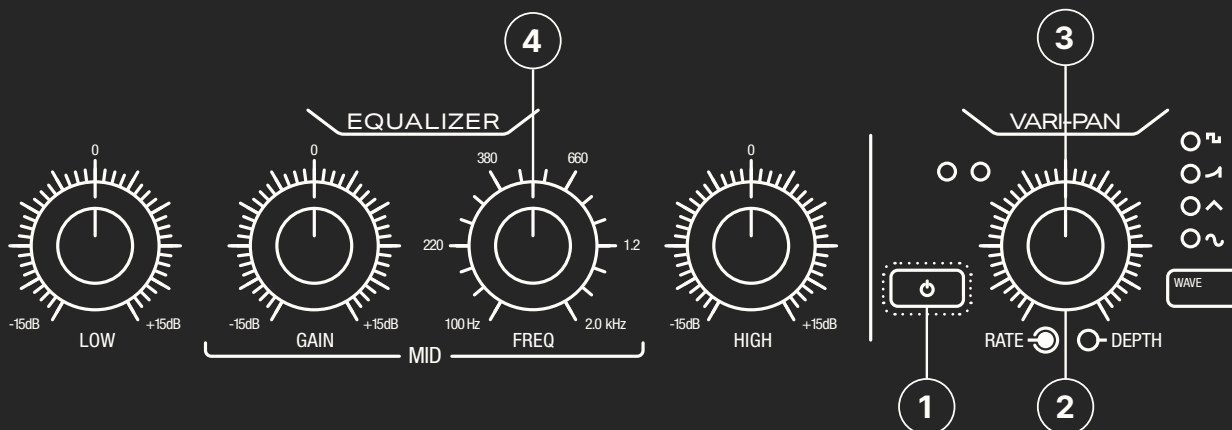

1. PRESS AND HOLD VARI-PAN ON/OFF > ENTERS PREAMP/EQ ALTERNATIVE MODE
2. ADJUST VARI-PAN DEPTH > ADJUSTS DRIVE VCA AMOUNT
3. ADJUST VARI-PAN RATE > ADJUSTS FX SEND VCA AMOUNT
4. ADJUST MID FREQ > ADJUSTS EQ MID FREQ RESONANCE AMOUNT

FX SECTION ALTERNATIVE MODES

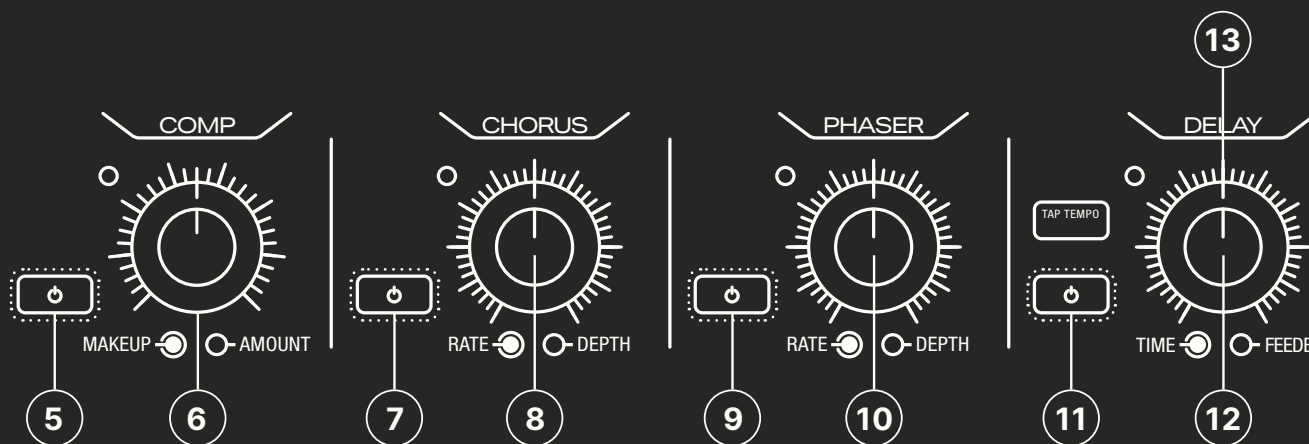

5. PRESS AND HOLD COMPRESSOR ON/OFF > ENTER COMPRESSOR ALTERNATIVE MODE
6. ADJUST COMPRESSOR AMOUNT > ADJUSTS COMPRESSOR RATIO
7. PRESS AND HOLD CHORUS ON/OFF > ENTERS CHORUS ALTERNATIVE MODE
8. ADJUST CHORUS RATE > ADJUSTS CHORUS TIME
9. PRESS AND HOLD PHASER ON/OFF > ENTERS PHASER ALTERNATIVE MODE
10. ADJUST PHASER RATE > ADJUSTS PHASER FREQUENCY
11. PRESS AND HOLD DELAY ON/OFF > ENTERS DELAY ALTERNATIVE MODE
12. ADJUST DELAY RATE > ADJUSTS DELAY SPREAD
13. ADJUST DELAY AMOUNT > ADJUSTS DELAY JITTER

Chapter 4

CONTROL INPUTS 1 & 2 / USING EXPRESSION PEDALS

1

CONNECTING AND ASSIGNING (PREAMP MODEL)

The MK8 allows 2 expression pedals to be connected simultaneously for hands-free control of preamp or FX parameters. Once connected, these can be easily assigned from the front panel on the fly. For example, switch to pedal wah just for a chorus of a song, or spin in the delay effect just on the tail of a phrase (FX version only).



Please Note: expression pedal inputs are scaled 0V to 5V at the inputs by default. The inputs can be a standard passive expression pedal such as a ROLAND EV-5 or MOOG EP-3, or any analog control voltage such as a Eurorack modular or classic analog synthesizer. This allows for a new range of expressivity and connectivity to classic analog instruments.



If the input range of your expression pedal or control voltage is not scaled to this full range, a simple and quick calibration procedure (described below on Page 23) can be implemented to scale the expression destination to the full range of your input source.



To cancel all current expression pedal assignments quickly, press and hold the 1 or 2 button for 0.5 secs in the preamp or FX Control sections.

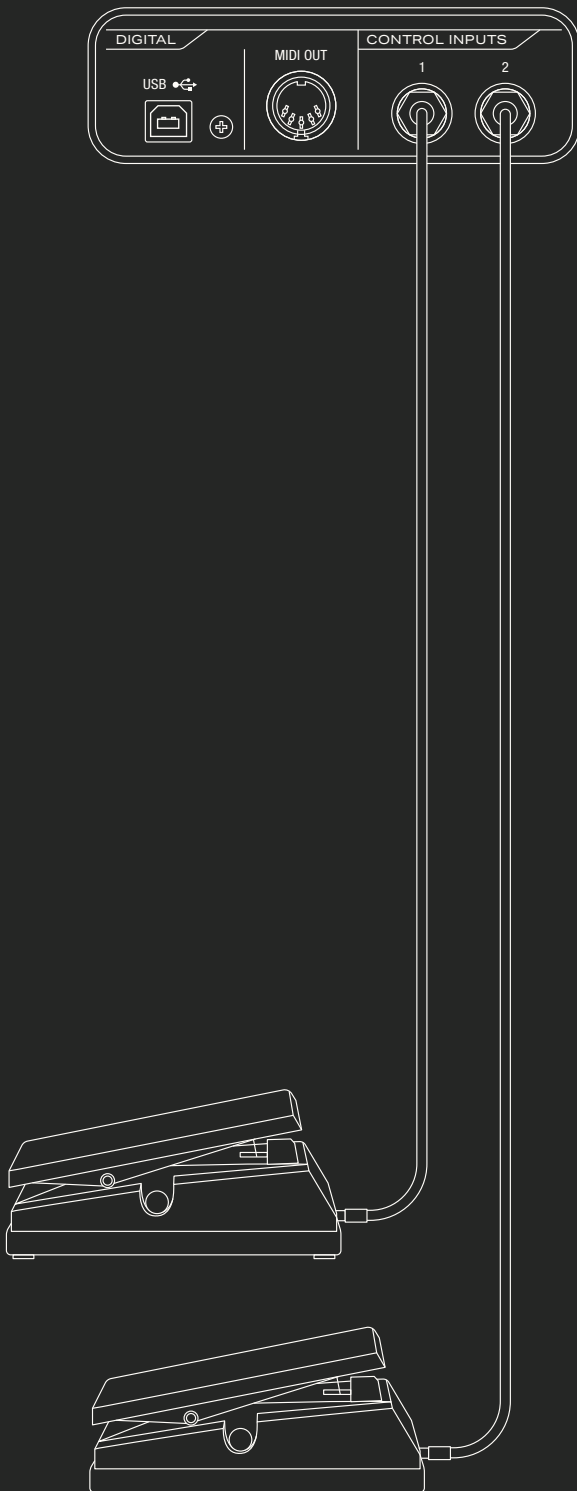

2

CONTROL INPUT 1 FOR VOLUME/WAH

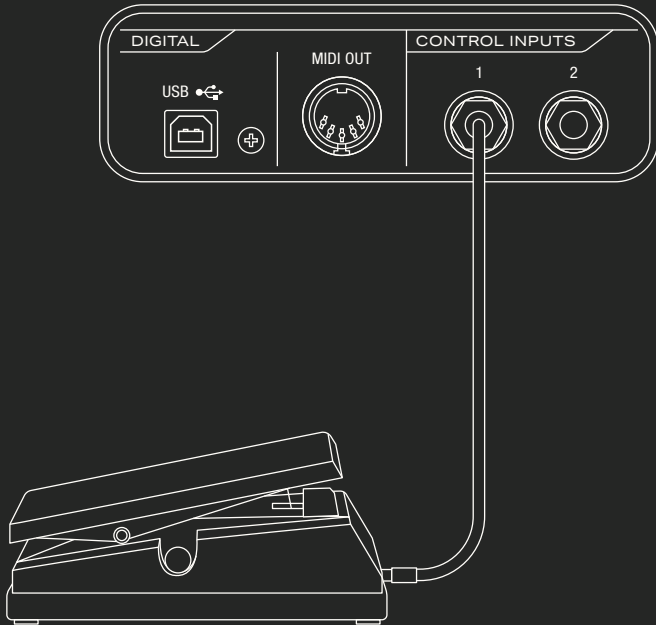

1. Connect a suitable expression pedal to Control Input 1 found on the right-hand side of the MK8 when looking from the front.
2. Place your pedal(s) at a suitable position under the MK8.
3. To assign volume, freq (wah) or both, simply select volume or wah (or both) using the 1 button in the Control section on the MK8's front panel.

VOLUME MODE: When selected (VOL LED is illuminated), the expression input will control the volume of the output VCA's in the pre-amp section. When at minimum, there will be no sound, and when at maximum, the output will be at maximum volume for the current settings.

⚠ **Please Note:** the VCA which controls the volume of the preamp and Vari-Pan circuits sits before and independently of the front-panel VOLUME control. The front-panel VOLUME control will still set the overall volume coming out of the instrument.

⚠ **The max volume is set by the front panel volume control and the expression pedal sweeps the volume from its minimum setting up to the front panel setting.**

FREQ MODE: When selected (FREQ LED is illuminated), the expression input will control the frequency of the MID EQ section.

⚠ **Please Note:** If the MID GAIN is set to 0dB (knob is centered), the expression input will have no sonic effect. The expression input is "additive" like a classic control-voltage on an analog synth.

⚠ **To effectively set the frequency range of the expression input, put your expression input to its minimum setting and set your desired starting frequency using the front-panel FREQ control. The expression input will then sweep from that front-panel starting frequency up to higher frequencies. To avoid unpleasant sonic artifacts, the maximum frequency is clamped to around 5.5KHz.**

⚠ **The max frequency is set by the front panel mid frequency control and the expression pedal sweeps the frequency from its minimum setting up to the front panel setting.**

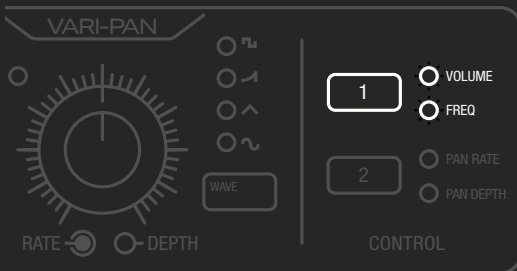

3

CONTROL INPUT 2 FOR VARI-PAN RATE AND DEPTH

1. Connect a suitable expression pedal to Control Input 2 found on the right-hand side of the MK8 when looking from the front.
2. Place your pedal(s) at a suitable position under the MK8.
3. To assign Vari-Pan Rate, Depth or both, simply select pan rate or pan depth (or both) using the 2 button in the Control section on the MK8's front panel.

RATE MODE: When selected (RATE LED is illuminated), the expression input will control the rate of the vari-pan circuit. In this mode, the maximum frequency of the rate is set by the front-panel RATE control and the expression pedal sweeps the vari-pan rate from its minimum setting up to the front-panel setting.

DEPTH MODE: When selected (DEPTH LED is illuminated), the expression input will control the depth of the vari-pan circuit. In this mode, the maximum depth is set by the front-panel DEPTH control and the expression pedal sweeps the vari-pan DEPTH from its minimum setting up to the front-panel setting.

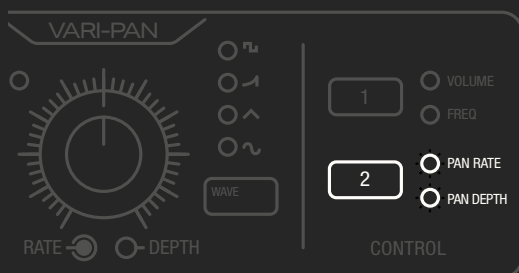
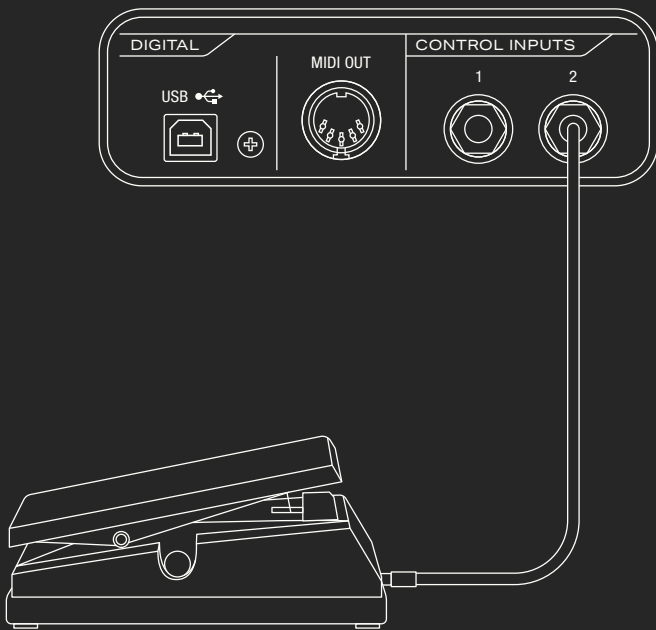

4

CONNECTING AND ASSIGNING (FX MODEL)

CONTROL INPUT 1 (FOR CHORUS/PHASER RATE)



1. Connect a suitable expression pedal to Control Input 1 (found on the right-hand side of the MK8 when looking from the front).
2. Place your pedal(s) at a suitable position under the MK8.
3. To assign Chorus Rate, Phaser Rate or both, simply select Chorus Rate, Phaser Rate (or both) using the 1 button in the FX Control section on the MK8's front panel.
4. CHORUS/PHASER RATE MODE : When selected (CHORUS RATE or PHASER RATE LED is illuminated, or both), the expression input will control the rate of the Chorus, Phaser or both effects simultaneously.

⚠ Please Note: The max rate is set by the front panel Chorus and/or Phaser Rate control and the expression pedal sweeps the Chorus and/or Phaser Rate from its minimum setting up to the front panel setting.

CONTROL INPUT 2 (FOR DELAY TIME/DELAY MIX)



DELAY TIME MODE : When selected (DELAY TIME LED is illuminated), the expression input/pedal will control the Delay Time parameter. The length of the delay will increase or decrease according to the expression pedal position.

DELAY MIX MODE: When selected (DELAY MIX LED is illuminated), the expression input/pedal will control the Delay Mix parameter. The Delay Mix level will increase or decrease according to the expression pedal position.

⚠ Please note: The expression input is "additive" like a classic control-voltage on an analog synth. The max Delay Time or Mix level is set by the front panel Delay Time or Mix control and the expression pedal sweeps the frequency from its minimum setting up to the front panel setting.

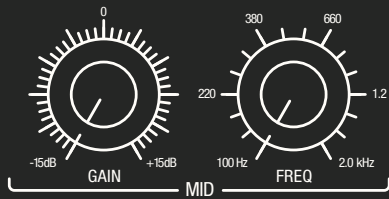

5

HIDDEN SLOW PHASER EFFECT

Turn the mid frequency and gain controls fully anti-clockwise, Press button 1 in the preamp CONTROL section until the FREQ LED is on, then using an expression pedal in Control Input 1, sweep the expression pedal to hear the effect. This effect can also work using the envelope dial in place of the expression pedal. For this, remove the expression pedal, turn mid frequency and gain fully anti clockwise and use keyboard velocity to introduce more or less phasing.



6

CALIBRATING YOUR EXPRESSION / CONTROL INPUTS

1. Connect your expression pedal or control-voltage source to the control input that you would like to use and calibrate (A).
2. PRESS AND HOLD the CORRESPONDING Control button (1 or 2) in the Preamp Control (B) or FX Control section (C) until the two button LED'S start flashing in unison at 2Hz. While HOLDING the corresponding button down (make sure that if your pedal is in Control Input 1 that you hold button 1), then slowly sweep your expression pedal or control voltage source through the range that you would like to use, making sure that both the minimum and maximum ranges of the control inputs have been represented.
3. Release the Control 1 or 2 button.
4. The control input for that expression channel has now been calibrated and will control the full range of the effect selected for that channel.

RIGHT SIDE OF PIANO

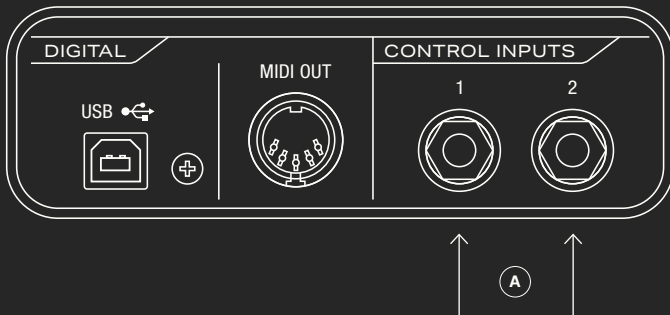

PREAMP CONTROL



FX CONTROL

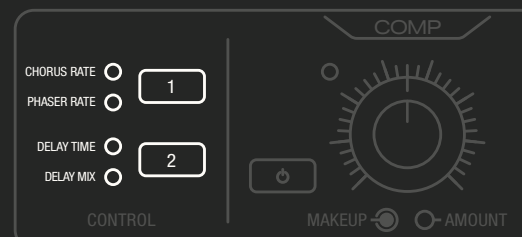

Chapter 5

TUNING, VOICING AND MAINTENANCE

Your MK8 is designed to require minimal maintenance, however it is worth familiarising yourself with the inside of the piano so that you can adjust things to taste or tune the instrument.

⚠ Please Note: To access under the lid, remove the 2 Phillips screws (using a Phillips screwdriver) from the metal bar at the rear of the lid, grip the lid firmly from both sides (standing behind the piano), then pull the lid backwards and lift up to remove completely from the piano.

TUNING

Though the MK8 is designed to stay in tune (even under touring conditions) it is nonetheless worth checking the tuning from time to time using a chromatic tuner. We recommend the Peterson iStroboSoft App available from the Apple store or Android store.

VOICING (TINE TO PICKUP POSITIONING, FOR EVEN TONAL RESPONSE)

Your MK8 was expertly set at our factory so we advise not to touch the voicing of the piano. However, if you wish to thicken or thin out a particular note (adding fewer or more harmonics) then simply use the voicing screw to adjust the tine angle in relation to the front of the pickup.

Also, if you desire to decrease or increase volume on a particular note, simply loosen the pickup screw of the note in question and slide the pickup closer (more volume) or further away from the tine (less volume).

⚠ Please Note: The closer the pickup to the tine the more aggressive the sound but also the more saturation that will occur (which may or may not be desirable for your sound or style of playing). Also be careful not to place the pickup too close to the tines as this can result in the following scenarios. Firstly, in the bass region the magnetic field of the pickup can induce upwards pitch change on the lower longer tines. Secondly, the tine can come into contact with the pickup head causing a nasty metallic clank, or worse, stop the tine moving completely

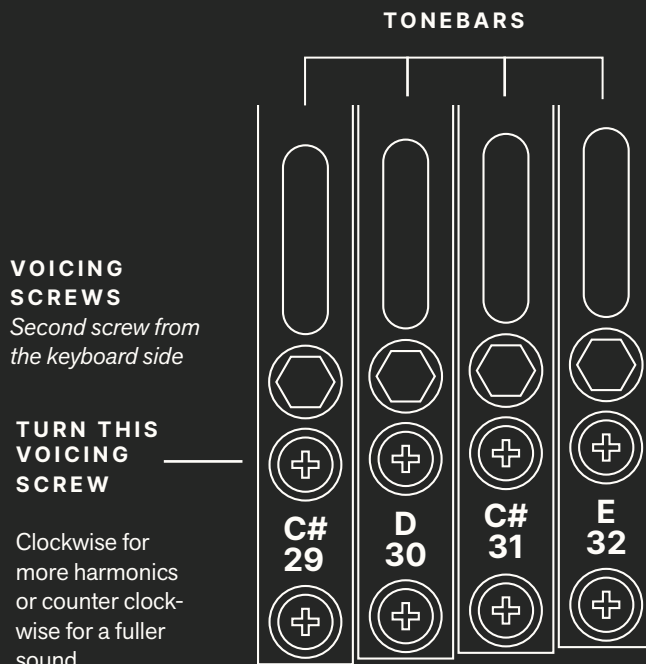

IDEAL TINE TO PICKUP SETTINGS

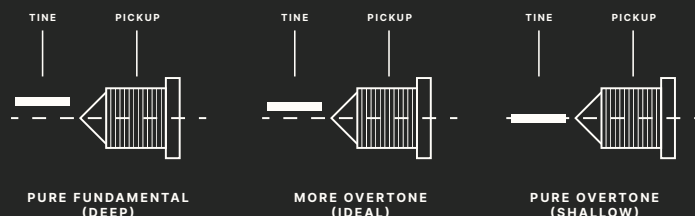

CLEANING YOUR MK8

- ⚠ Make sure your piano is turned off. Please use a non-abrasive, soft microfibre cloth with a 'plastic safe' non-abrasive foaming spray for the lid, keys and front panel. We recommend Amberclens Anti-Static Foaming Cleaner.**
- ⚠ Please take care not to spray any cleaner into sockets, openings or near power outlets!**
- ⚠ Please follow the safety information carefully found at the beginning of this manual!**

Chapter 6

TROUBLESHOOTING

NO POWER

1. Check mains power outlet is on.
2. Check mains plug is plugged fully into the wall outlet.
3. Check mains lead is fully plugged into AC adaptor.
4. Check 4-pin power XLR is plugged fully into the MK8 power input.
5. Check power switch is set to the on position.

NO SOUND

1. Check audio leads are plugged in and working.
2. Check the main volume control is up.
3. Check the main volume is up on your amplifier, speakers or other monitoring system.
4. Check the thumb wheel volume is up (headphones only).
5. Check that expression pedal assignments are off and/or expression pedal isn't in the heel down position (volume assignment).

SOUND IS DISTORTED

1. Check that the Drive light isn't on.
2. Check your amp/monitoring volume/drive settings.

KEY STUCK DOWN

1. Check for foreign objects between keys and remove if found.
2. Remove lid and check that a hammer hasn't stuck between tines, if so push it back down and check tonebar/tine alignment.

NOTES RINGING OUT WITH SUSTAIN PEDAL DISENGAGED

1. Remove lid. Make sure all the damper felts are attached and that none are missing.
2. Check the push rod that protrudes out of the piano can move freely and isn't snagged on anything.
3. Make sure the bridle strap hasn't slipped off the damper tongue.

SUSTAINING UNEVENLY

1. Make sure the black metal tube (pedal collar) that plugs into the bottom of the piano is fully screwed in and locked.
2. Make sure the knurled connector is screwed fully onto the push rod that protrudes from the bottom of the piano.

Sound Setting examples

1. TALKIN' LOUD



2. LEZLIE



3. AUTO-WAHRI

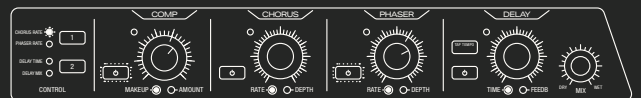

4. TRANSISTOR ORGAN



5. RING MODDER

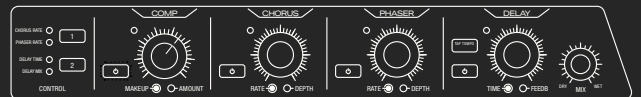

6. RAMP AND FILTER.



Your Sound Settings

Please print or photograph this page to note down your favourite MK8 front panel settings

1.



2.



3.



4.



5.



6.



CREDITS

Rhodes Leadership Team: Matt Pelling CEO, Tim Dawson
CFO, Dan Goldman CPO
Operations Director: Ian Peacock
Marketing Coordinator: Christian Dumouchel
Customer Service Manager: Ronan Peaker
Production Team Leader: Oliver Harvey Ball
QC Team Leader: Freya Horsey
Purchasing Manager: Ben Barker
Piano Technicians: Jack Straker, Theo Fieldhouse, William
Schultz, Joe Lumely, Joe Byron
Hardware Design: Axel Hartmann, Dan Goldman
Mechanical Design: James Cope, Klaus Webber
Chief Electronics Engineer: Cyril Lance
Electronic Engineering: James Evans
Artist Relations, Sales & Education - Jamie Bullock
Accounts Manager: Alex Smith

Manual Written: By Dan Goldman
Additional Technical Info: Cyril Lance
Manual Layout and Illustrations: Paul Kelly

Rhodes extends a huge thankyou to all our customers and
our manufacturing partners in the UK and worldwide.

Please Note: All information contained in this manual is
subject to change without notice. No part of this manual may
be reproduced or transmitted in any form without the express
written permission of Rhodes Music Group LTD.

Copyright 2023 Rhodes Music Group LTD.

WARRANTY

Please see the Members Club area on the Rhodes
website for up to date warranty information.

WWW.RHODESMUSIC.COM

TECHNICAL SPECIFICATIONS

MODELS MK8 S /MK8 FX

ANALOG PREAMP

True analogue signal path. Volume, drive, envelope controls. Expression pedal control of volume, mid sweep (wah), pan speed, pan depth. Rhodes custom analogue tri-band (low/mid/high) active equaliser (+/- 15db range). Voltage-controlled, resonant midrange filter. Rhodes custom vari-pan with variable rate/depth. 4 wave shapes and audio-rate modulation.

ANALOG EFFECTS OPTION

Rhodes custom stereo effect processor: VCA compressor, phaser, Bucket brigade chorus, delay. Expression pedal control of phaser speed, chorus speed, delay time, delay mix.

POWER SUPPLY

15-Volt, 4-pin locking XLR external supply with universal voltage.

KEYBOARD

73-note (E8-E80) Rhodes custom spruce keyboard by Kluge Klaviaturen GmbH, oak and beech key frame.

PICKUPS

Rhodes custom precision-wound alnico pickups with anti-slip adjustment for accurate voicing and flat-ended pickup heads for accurate volume adjustment.

ACTION

Rhodes custom high-impact ABS hammers and combs, quad-zone hard-wearing tips, aerospace-grade damper combs, black natural wool damper felts.

STONE GENERATION

Rhodes custom precision steel tines and tonebars, sustainably sourced Baltic birch tine and pickup rails.

LEFT SIDE CONNECTION PANEL

2 x Balanced XLR outputs (L/R), 2 x 1/4" jack Outputs (L/R), 1 x 1/4" jack send (direct pickup output), 1 x 1/4" return.

HEADPHONES

1 x 1/4" headphone jack, independent volume control.

UI PANELS

Standard: Scratch-resistant brushed-aluminium foil.

Legend: Black with silver legend or silver with black legend.

PEDAL

Rhodes custom twist-lock piano connector with flexi-cable. Chrome aluminium footplate. Rhodes folding protective non-slip mat.

FRONT PANEL AND REAR GRILLE

Standard: Black/Silver anodised aluminium.

RIGHT SIDE CONNECTION PANEL

USB: Reserved for future firmware updates.

2 x assignable jack expression pedal inputs.

MIDI out DIN socket, reserved for future MIDI capability

STAND

Rhodes custom telescopic (L/R adjustment) powder coated black steel/ mirror-chrome steel.

Height adjustable front legs. Folds compactly for transport.

HOOD

Black ABS, custom colours.

CASE

Lightweight ply case with tolex, aluminium base plate. Solid walnut option.

WEIGHT

75lbs/34kg

DIMENSIONS

1153 (w) x 563 (d) x 225 (h)